

BMU 9060-10

Asistent

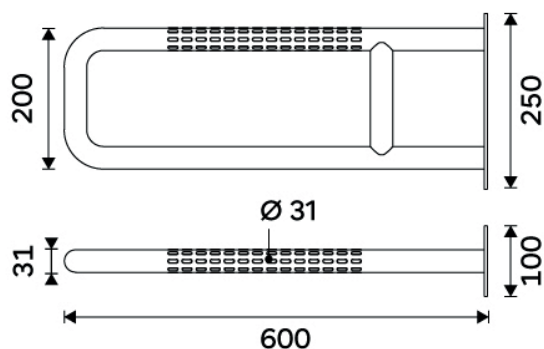

→ 100 ↑ 250 ↗ 600

Pevné podpěrné madlo 600 mm

Tvaru U. Průměr 32mm. Povrch kartáčovaný - mat. Nerezová ocel 1.4301 (18/8). Maximální nosnost 150 kg.

Fixed support grab bar 600 mm

U shape. Diameter 32 mm. Brushed surface - matt. Stainless steel (18/8). 150 kg maximum load.

Náhradní díly / Spare parts

montáž / installation :



montážní konzole / installation bracket :

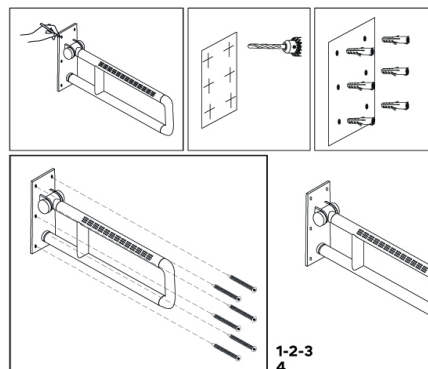

materiál - úprava (barva) / material - surface finish (colour) :
nerez 1.4301 (18/8)-Kartáčovaná nerez 1.4301.
stainless steel 18/8-brushed stainless steel 18/8



→ 6000
↑ 1000
↗ 2500

EAN : 8595187119550



ROMVEL spol. s r. o.
Dr. Milady Horákové 561/86a
Liberec 7, 460 07
Česká Republika / Czech Republic

T: (+420) 485 105 671
T: (+420) 485 107 441
F: (+420) 485 105 674
E: nimco@nimco.cz



www.nimco.cz